



PB series



PB series is the everyday choice for a cost effective power, data, USB fast charging and AV distribution unit.

Coming in a rugged black boxed housing, PB series is primarily an off the shelf unit in standard configurations. Other colour sockets are available for multi-purpose coding by special order.

The sockets used in PB series are part of our global modular component range including data, TUF and VGA options in addition to power.

PB series has multiple mounting options including in screen and is compatible with the Elsafe cable basket ranges by clipping onto the PATHWAY cable basket.



PB series technical

Common Modular 53mm Components*

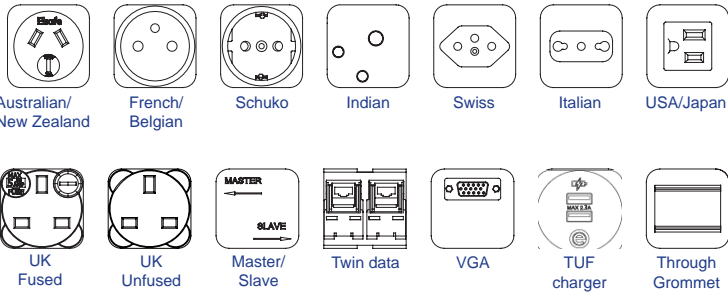

Screen Fixing

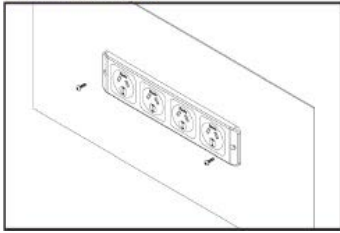

Beam Fixing

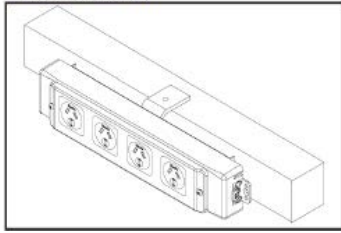

Standard Fixing

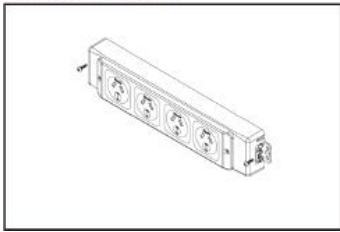

Through Body Fixing

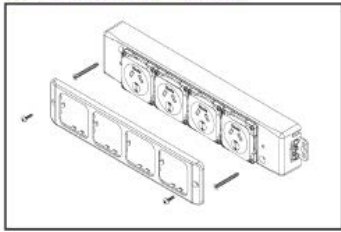

Cable Tray Fixing

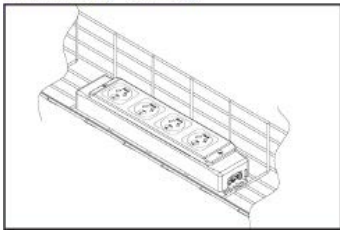

Underdesk Fixing

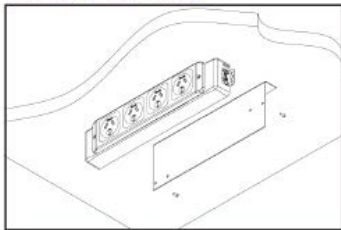

Features:

Configuration:

Power only / Data only / TUF charger / Combined (Power & Data/AV)
Internal segregation between Power and Data/AV in combined PBs.

Insulation:

Reinforced insulation

Testing:

100% testing - continuity, polarity, insulation & earth.

Soft Wiring (power):

Power wired to Wieland GST connector allows starter cables to be changed to suit requirements, especially useful during moves and changes (CHURN).

PB2

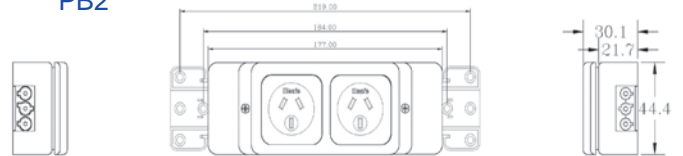

PB3

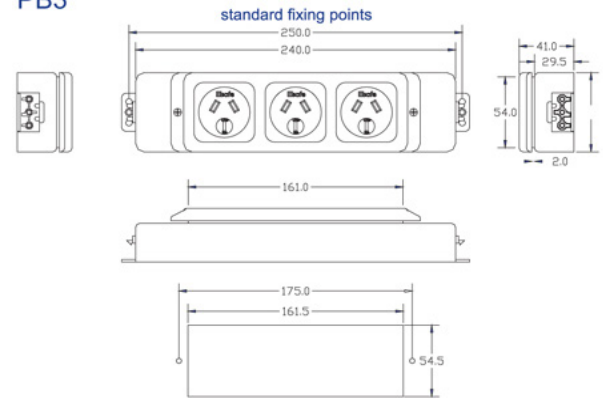

PB4

